

CONTINENTAL



HYDRAULICS™

CONTINENTAL HYDRAULICS

# VSD03M

SOLENOID OPERATED DIRECTIONAL VALVES

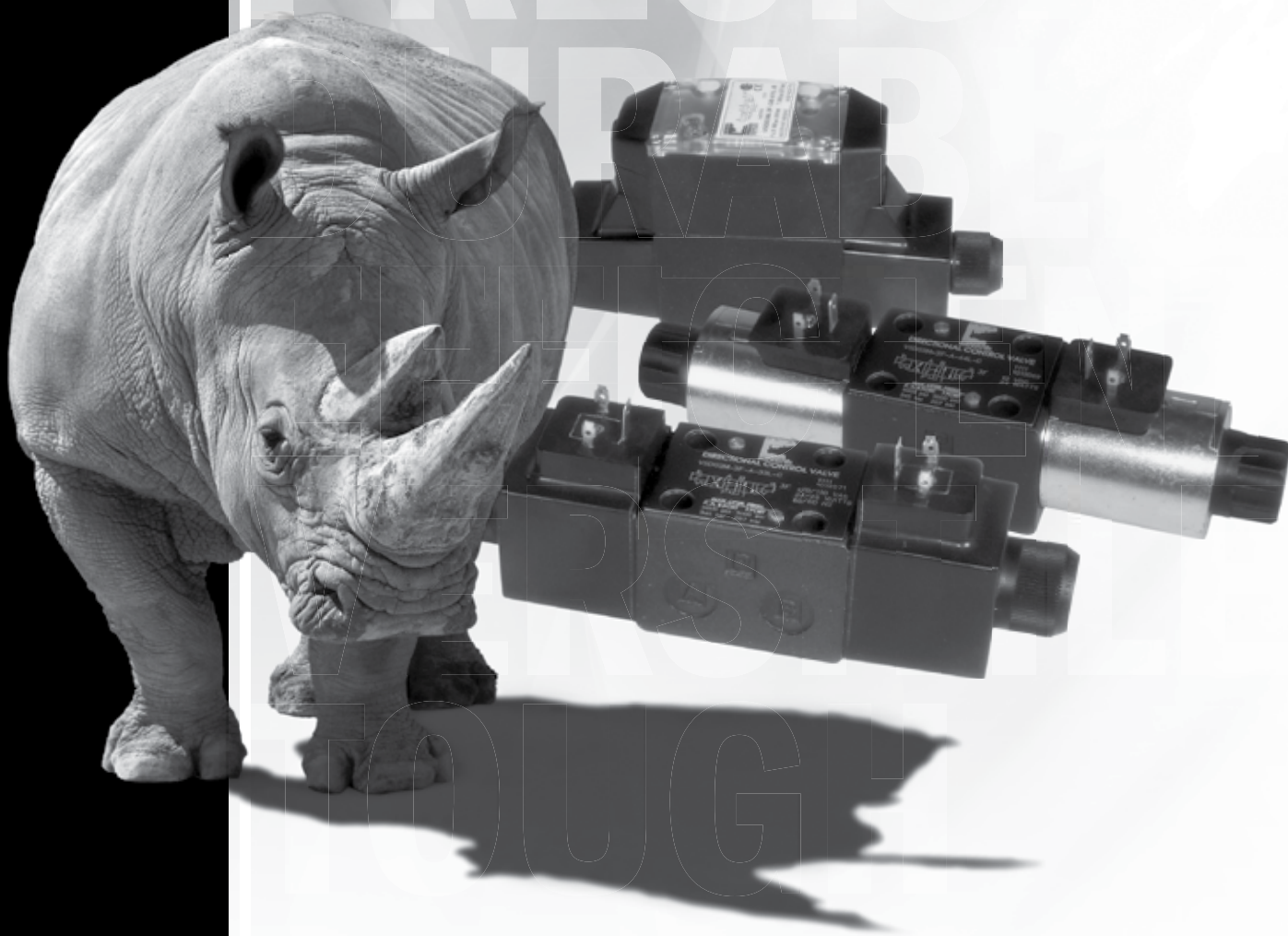

VSD03M - SOLENOID OPERATED DIRECTIONAL VALVES

# VSD03M

## SOLENOID OPERATED DIRECTIONAL VALVES

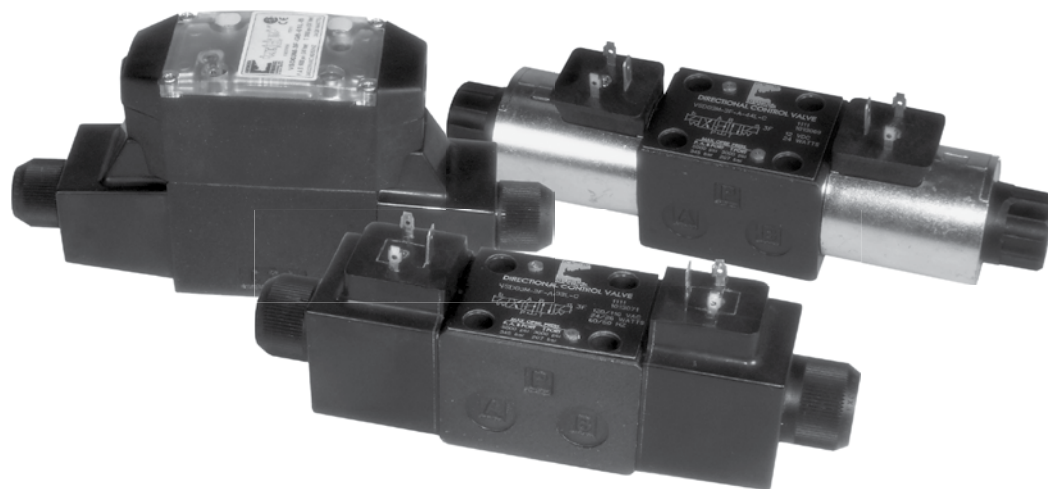

### DESCRIPTION

These valves conform to NFPA D03 and ISO 4401 mounting standards. They are available in both 3 way and 4 way styles.

All versions are available in 2 position spring offset, 2 position detent, 2 position spring centered and 3 position spring centered versions.

A wide range of spools are available.

Standard and CSA approved versions are available.

### TYPICAL PERFORMANCE SPECIFICATIONS

<b>MAXIMUM OPERATING PRESSURE</b>	P - A - B Ports	Standard	5000 psi	350 bar
		CSA	4000 psi	275 bar
	T Port	Standard	3000 psi	210 bar
		CSA	2500 psi	172 bar
<b>FLOW RATE</b>			20 gpm	76 l/min
<b>MOUNTING SURFACE</b>			NFPA D03 ISO 4401-03-02-0-03	
<b>MAXIMUM WEIGHT</b>	AC		4 lbs	1.8 kg
	DC		4.6 lbs	2.1 kg

<b>RANGE TEMPERATURES</b>	Ambient		-4 to +130°F	-20 to +54°C
	Fluid	Standard	-4 to +180°F	-20 to +82°C
		CSA	-4 to +150°F	-20 to +66°C
<b>FLUID VISCOSITY</b>	Range		60-1900 SUS	10-400 cSt
	Recommended		120 SUS	25 cSt
<b>FLUID CONTAMINATION</b>			ISO 4406:1999 Class 20/18/15	

# IDENTIFICATION CODE

**VSD03M** - [ ] [ ] - [ ] [ ] [ ] [ ] - [ ] - [ ] **L** - [ ] \_\_\_\_\_ DESIGN LETTER

**SOLENOIDS** - See the codes on page 10

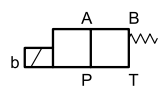
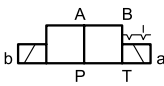
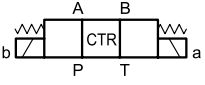
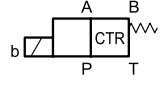
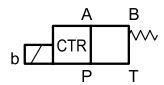
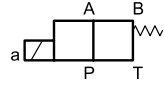
FUNCTION	
1	 <p>Single Solenoid 2 Position Spring Offset</p>
	 <p>Dual Solenoid 2 Position Detented (No Spring)</p>
3	 <p>Dual Solenoid 3 Position Spring Centered</p>
	 <p>Single Solenoid 2 Position Spring Centered</p>
6	 <p>Single Solenoid 2 Position Energize To Center</p>
	 <p>Single Operator 2 Position - 3 Way Spring Offset</p>

SEAL	
<b>A</b>	Buna (STD)
<b>G</b>	Viton

Spool Type  
See Next Page

MECHANICAL OMIT IF NOT REQUIRED	
<b>R</b>	Single Solenoid Operator At 'B' Port End.
<b>WD</b>	Wash-Down

CONNECTION BOX OPTIONS OMIT IF NOT REQUIRED	
See the codes on page 9	

ELECTRICAL OPTION	
<b>OMIT</b>	Plug-in terminal solenoids or lead wires
<b>B</b>	Connection box with terminal posts and lights

APPROVALS	
<b>OMIT</b>	STD VALVE
<b>CSA</b>	CSA US/CAN

TYPICAL ORDERING CODE:  
**VSD03M-3A-AB5A-60L-C**  
**VSD03M-3A-A-33L-C**

VSD03M - SOLENOID OPERATED DIRECTIONAL VALVES

SPOOLS					
NAME	SYMBOL	FUNCTION	CENTER POSITION	CROSSOVER	FUNCTION MATCHING
A			All ports blocked	P→B or P→A T blocked	1, 2, 3, 5, 6
A1			All ports blocked	P→B and A→T restricted or P→A and B→T restricted	3, 5
B			All ports open	All ports open	1, 2, 3, 5, 6
E			P and A blocked, and B→T	All ports blocked or P and A blocked and B→T	3, 5
E1			P and A blocked, B restricted to T	All ports blocked or A blocked and B→T restricted	3, 5
F			P blocked, A→T and B→T	P blocked and A→T or B→T	3, 5, 6
F1			P blocked, A and B restricted to T	P blocked, A or B restricted to T	3, 5, 6
G			P to A and B T blocked	P→B or P→A T blocked	
H			P and A to T, B blocked	All ports open, restricted	
J			P→B A and T blocked	P→B and A blocked or all ports blocked	3, 5
K			P and B blocked, and A→T	P and B blocked and A→T or all ports blocked	3, 5, 6
K1			P and B blocked, A restricted to T	P blocked and A→T restricted or all ports blocked	
L			P→T, A and B blocked	All ports open, restricted	
N			P→A B and T blocked	All ports blocked, or P→A B and T blocked	3, 5, 6
Q			P and B to T, A blocked	All ports open, restricted	3, 5
X			-	All ports blocked	9
AN			-	All ports blocked	2
AJ			-	All ports blocked	2

These are the standard configurations. Contact Continental Hydraulics for special versions.

# PRESSURE DROPS ΔP-Q

(OBTAINED WITH VISCOSITY OF 170 SUS - 36 CST AT 70°F - 50°C)

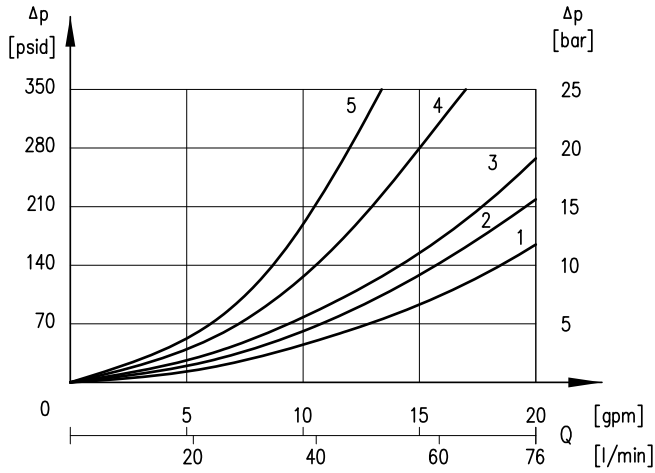

SPOOL	FLOW CURVE NUMBER				
	SHIFTED				CENTER
	P→A	P→B	A→T	B→T	P→T
<b>A, A1, K1, F1, E1</b>	2	2	3	3	
<b>B</b>	1	1	3	3	2
<b>E</b>	2	2	3	1	
<b>F</b>	3	3	1	1	
<b>G</b>	1	3	1	3	
<b>H, Q</b>	4	5	5	5	3
<b>J</b>	2	1	3	3	
<b>K</b>	2	2	1	3	
<b>L</b>	5	5	5	5	3
<b>N</b>	1	2	3	3	
<b>1A, 2A, 2AN, 2AJ</b>	3	3	3	3	
<b>1A, 1B, 2A</b>	2	2	2	2	
<b>9X</b>	3	3			

# PERFORMANCE CURVE

## DC VOLTAGE

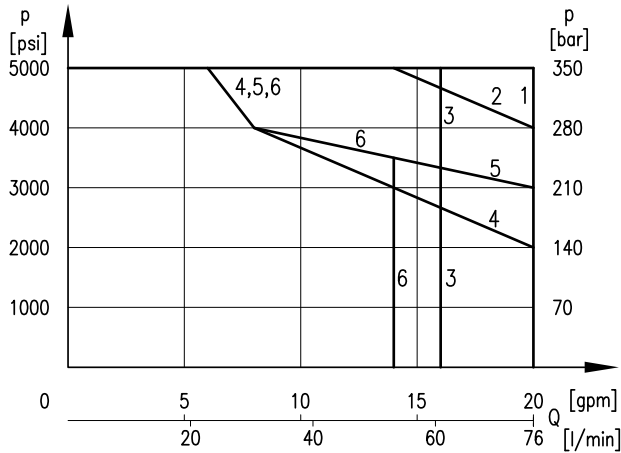

CURVE	SPOOL
<b>1</b>	A, 2A, A1, AN, AJ, E1, G, K1, J, N, X
<b>2</b>	F1
<b>3</b>	H, L, Q, B
<b>4</b>	F
<b>5</b>	1A
<b>6</b>	1B, E, K

VSD03M - SOLENOID OPERATED DIRECTIONAL VALVES

# PERFORMANCE CURVE

## AC VOLTAGE

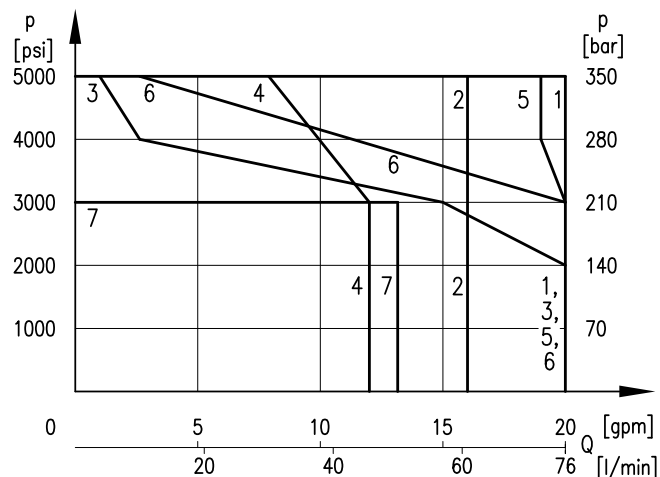

CURVE	SPOOL
1	A, A1, G, AN, AJ, X.
2	B
3	F
4	L, H, Q
5	J, N
6	F1, E1, K1
7	K, E

### NOTES:

1. The values indicated in the graphs are relevant to the standard solenoid valve, with 42L coils.
2. Valve performance was tested in a four way circuit (full loop). Performances may be reduced from that shown when used in a three-way circuit (half circuit), i.e. A or B port plugged.
3. The values have been obtained according to ISO 6403 norm with solenoids at rated temperature and supplied with voltage equal to 90% of the nominal voltage. The value have been obtained with filtration according to ISO 4406:1999 class 18/16/13.

## AC VOLTAGE - LOW FORCE

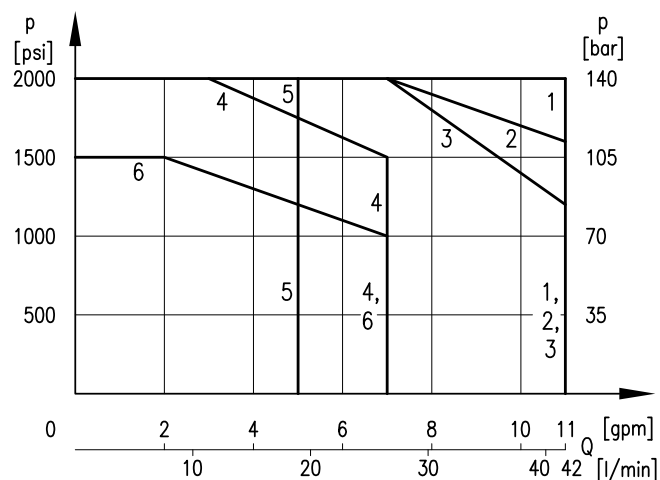

CURVE	SPOOL
1	2A, AN, B
2	1A, 1B, G
3	A
4	A1
5	L
6	F

# OVERALL AND MOUNTING DIMENSIONS - CONNECTION BOX VERSION

VSD03M-2\*, 3\*

Dimensions in mm [IN]

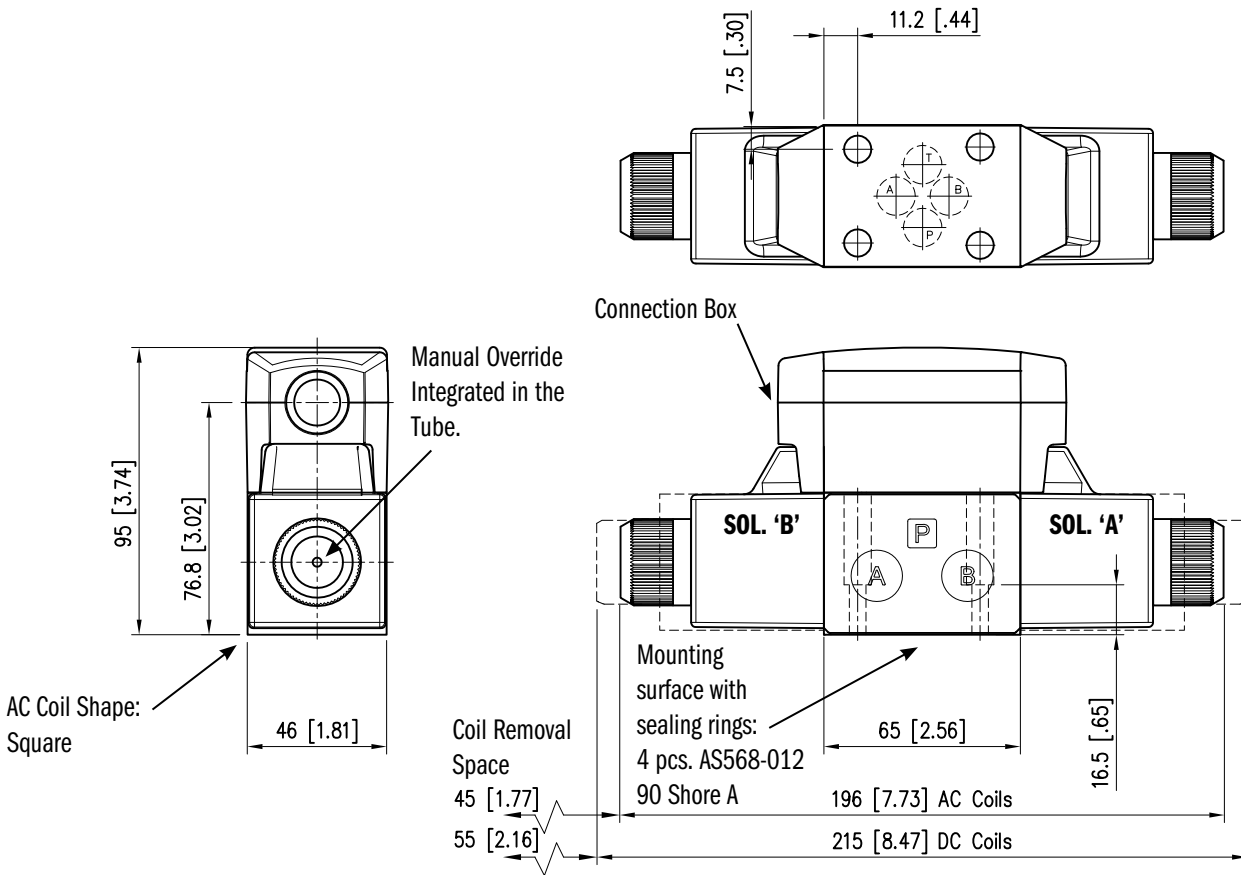

VSD03M-1\*, 5\*, 6\*, 9\*

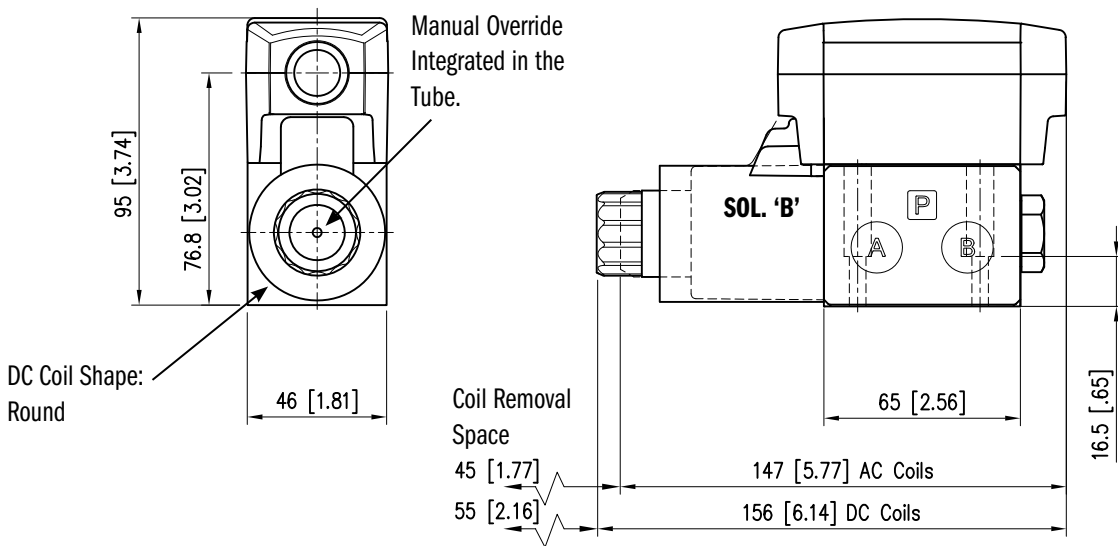

# OVERALL AND MOUNTING DIMENSIONS - DIN STYLE VERSION

VSD03M-2\*, 3\*

Dimensions in mm [IN]

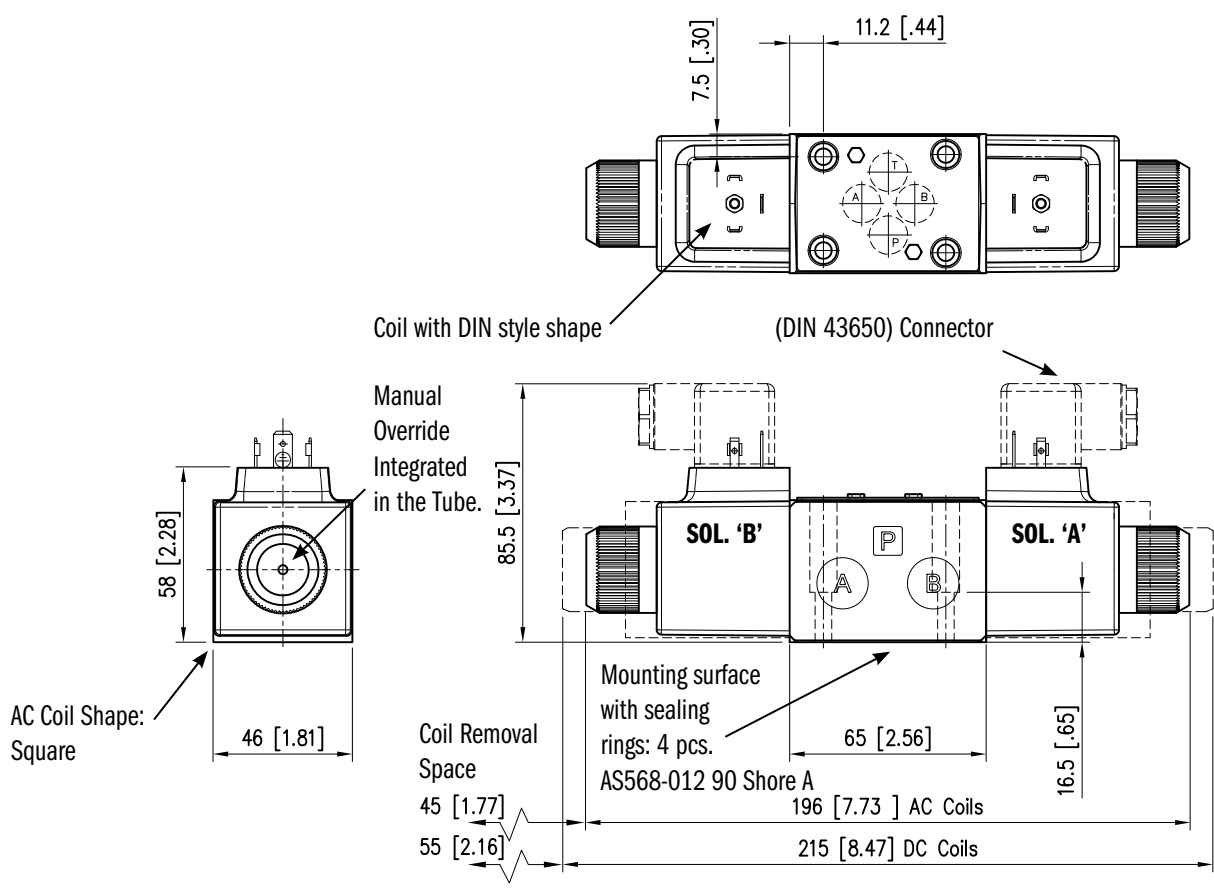

VSD03M-1\*, 5\*, 6\*, 9\*

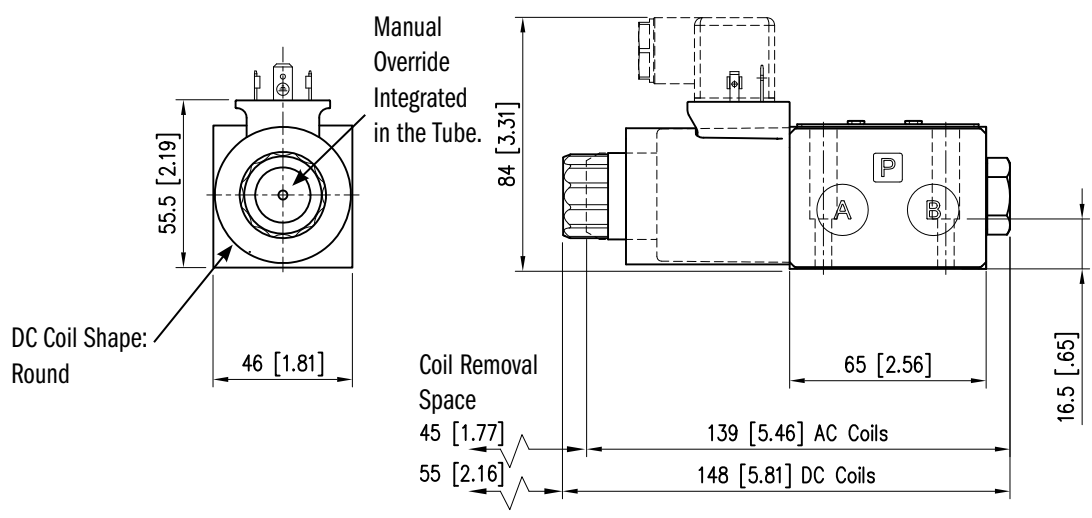

VSD03M - SOLENOID OPERATED DIRECTIONAL VALVES



# ELECTRICAL CHARACTERISTICS

Valves are available with an electrical connection box or with DIN 43650 solenoids in both AC and DC voltages. Deutsch DT04 or lead wires are also available in DC voltages only.

## CONNECTION BOX OPTIONS

To simplify the connections and prevent wiring mistakes, we offer the option with connection boxes with quick connect pin receptacles, already wired.

Valves are available with receptacles on solenoid side 'A' or 'B' and several connector styles.

Below are the codes to be included in the box 'option' of the ordering code, depending on the version you choose.

Wiring diagrams at right show the standard connections for 3-pin, 4-pin and 5-pin connectors. The commercially available mating "female" connector are not included.

CODE	PIN	SHAPE	PORT END	NOTES
5A	5	Male Mini	A	Single and Dual Solenoid
5H	5		B	
3A	3	Male Mini	A	Single Solenoid Only
3H	3		B	
4A	4	Male Micro	A	For DC Current Only. Different Wiring. See Schematics.
D4A	4		A	
4	4		B	
D4	4		B	

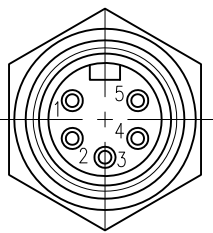

### 5 PIN RECEPTACLE

Male mini receptacles conform to NFPA/T3.5.29 R1 - 2007 used with single or double solenoid valve.

26 mm [1"] Wrench

1	Lead to Solenoid B
2	Lead to Solenoid A
3	Ground Lead (Green)
4	Lead to Solenoid A
5	Lead to Solenoid B

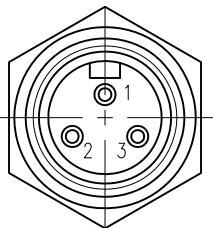

### 3 PIN RECEPTACLE

Male mini receptacles conform to NFPA/T3.5.29 R1 - 2007 used with single solenoid valve.

26 mm [1"] Wrench

1	Ground Lead (Green)
2	Lead to Solenoid
3	Lead to Solenoid

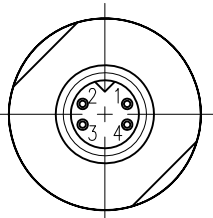

### 4 PIN RECEPTACLE

Male micro receptacles (M12x1 thread) used with DC valve only.

23 mm [7/8] Wrench

4A & 4		
1	Brown	Lead to Solenoid A
2	White	No Connection
3	Blue	Common Lead to Sol. A & B
4	Black	Lead to Solenoid B

D4A & D4		
1	Brown	No Connection
2	White	Lead to Solenoid A
3	Blue	Common Lead to Sol. A & B
4	Black	Lead to Solenoid B

# SOLENOIDS

Listed below the types of solenoids available and the numbers to be added in the solenoid box on page 3.

## PLUG-IN TERMINAL SOLENOID

### DIN 43650

This solenoid has three terminal posts. Use bi-polar connectors that meet ISO 4400 / DIN 43650 (EN 175301-803). Protection against atmospheric agent: IP 65

### LEAD WIRES

6 inch length, protection against atmospheric agent: IP 67

### DEUTSCH DT04 MALE

Protection against atmospheric agent: IP 69

Connectors must be ordered separately.

### DEUTSCH DT04 MALE

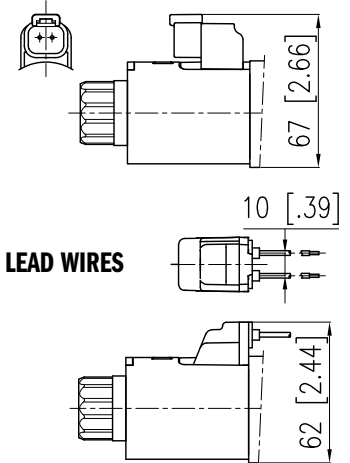

## CONNECTION BOX SOLENOIDS

This is a two pin solenoid which connects to the circuit board. Wiring is done on the terminal strip inside the box.

DIN CONNECTION CODE	LEAD WIRE CONNECTION CODE	DEUTSCH DT04 CONNECTION CODE	BOX CONNECTION CODE	VOLTAGE & FREQ. [VOLT - HERTZ]	VOLTAGE LIMITS [MIN - MAX]	RESISTANCE ±10% [OHM]	INRUSH CURRENT [A]	HOLDING CURRENT [A]	HOLDING POWER [W]
33	Not Available	Not Available	60	120 - 60 110 - 50	108 - 126 99 - 116	35.7	1.35 1.41	0.46 0.53	26 29
34	Not Available	Not Available	61	240 - 60 220 - 50	216 - 252 198 - 231	146.4	0.61 0.71	0.23 0.26	26 29
Not Available	Not Available	Not Available	68	120 - 60 110 - 50	108 - 132 99 - 121	75.8	0.72 0.74	0.22 0.24	12 13
42	24K4	24K7	70	24 V DC	21 - 26	19.2	1.25	1.25	30
44	12K4	12K7	75	12 V DC	10 - 13	4.8	2.5	2.5	30

## WASHDOWN OPTION (CODE WD)

The wash-down option with the electrical box is designed for an IP65 rating. This option uses a special cover without the mounting bolt access holes and uses silicone sealant to help seal between the coil and core tube.

The DIN, Deutsch and lead wire coils versions of the wash-down option uses silicone sealant to help seal between the coil and core tube.

# APPLICATION DATA

## FLUIDS

All pressure drops shown on these data pages are based on 170 SUS fluid viscosity and 0.87 specific gravity. For any other specific gravity (G1) the pressure drop ( $\Delta P$ ) will be approx.  $\Delta P1 = \Delta P (G1/G)$ . See the chart for other viscosities.

<b>FLUID VISCOSITIES</b>	Cst	10	14.5	32	36	43	54	65	76	86	108	216	324	400
	SUS	60	75	150	170	200	250	300	350	400	500	1000	1500	1900
<b>MULTIPLIER</b>		0.77	0.81	0.97	1.00	1.04	1.10	1.15	1.20	1.24	1.31	1.56	1.72	1.83

Use mineral oil-based hydraulic fluids HL or HM type, according to ISO 6743-4. For these fluids, use NBR seals. For fluids HFDR type (phosphate esters) use FPM seals (code G). For the use of other kinds of fluid such as HFA, HFB, HFC, please consult our technical department.

Using fluids at temperatures higher than 180 degrees F causes the accelerated degradation of seals as well as degradation of the fluids physical and chemical properties.

From a safety standpoint, temperatures above 130 degrees F are not recommended.

<b>RANGE TEMPERATURES:</b>	Ambient		-4 to +130 °F	-20 to +54 °C
	Fluid	STD	-4 to +180 °F	-20 to +82 °C
		CSA	-4 to +150 °F	-20 to +66 °C
<b>FLUID VISCOSITY</b>	Range		60 -1900 SUS	10 - 400 cSt
	Recommended		120 SUS	25 cSt
<b>FLUID CONTAMINATION</b>			ISO 4406:1999 Class 20/18/15	

## INSTALLATION

Valves with centering and return springs can be mounted in any position without impairing correct operation. Valves with mechanical detent should have horizontal mounting.

Valves are fixed by means of screws or tie rods on a flat surface with planarity and roughness equal to or better than those indicated in the relative symbols. If minimum values are not observed, fluid can easily leak between the valve and support surface.

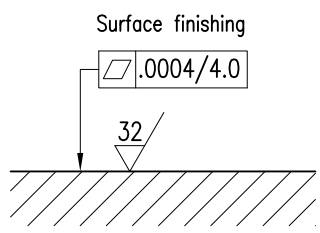

## SEAL KIT

Buna Seal Kit	1013326
Viton Seal Kit	1013327

## BOLT KIT

VSD03M	121472
--------	--------

POWERFUL  
ACCURATE  
INNOVATIVE  
PRECISE  
DURABLE  
EFFICIENT  
VERSATILE

## ABOUT CONTINENTAL HYDRAULICS

Rugged, durable, high-performance, efficient—the reason Continental Hydraulics' products are used in some of the most challenging applications across the globe. With a commitment to quality customer support and innovative engineering, Continental's pumps, valves, power units, mobile and custom products deliver what the markets demand. Continental has been serving the food production, brick and block, wood products, automotive and machine tool industries since 1962. Learn how our products survive some of the most harsh environments.

**SALES@CONTHYD.COM**

5505 WEST 123RD STREET • SAVAGE, MN 55378-1299 / PH: 952.895.6400 / FAX: 952.895.6444 / WWW.CONTINENTALHYDRAULICS.COM

CONTINENTAL



HYDRAULICS